

MEMS mirror

S13989-01H

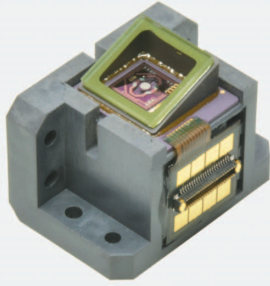

Miniature, high performance Electromagnetically driven two-dimensional laser scanning MEMS mirror

The S13989-01H is an electromagnetically driven mirror that incorporates our unique MEMS (micro-electro-mechanical systems) technology. The device was made smaller by arranging the magnet beneath the mirror. High reliability was achieved by employing a hermetic seal package. Electrical current flowing in the coil surrounding the mirror produces a Lorentz force based on Fleming's rule that drives the mirror. Hamamatsu MEMS mirrors offer a wide optical deflection angle and high mirror reflectivity.

Features

- Compact
- Wide optical deflection angle
- Low voltage drive: suitable for installation on equipment
- High reliability: hermetic seal package
- Slow axis: linear operation possible

Applications

- Machine vision (shape recognition)
- Industrial LiDAR
- Laser scanning microscope
- Various laser scan units

Structure and principle

In a MEMS mirror, a metallic coil is formed on a single-crystal silicon, a mirror is formed inside the coil through MEMS processing, and a magnet is arranged beneath the mirror. Within a magnetic field generated by the magnet, electrical current flowing in the coil surrounding the mirror produces a Lorentz force based on Fleming's rule that causes the mirror to tilt. In addition, the mirror can be driven two-dimensionally with the combination of two springs formed by MEMS processing. The path of the laser light incident on the mirror surface is varied in this way to scan and project. Compared to the electrostatic or piezoelectric driven mirrors, electromagnetically driven MEMS mirrors are lower voltage driven and easier to use.

Structure diagram

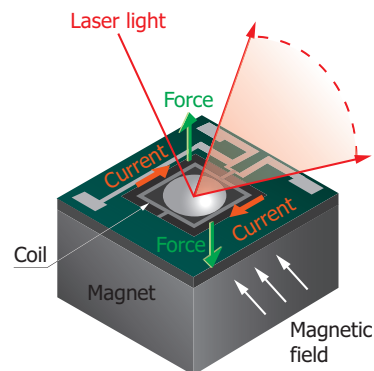

K0THC0058EB

▣ Absolute maximum ratings (Ta=25 °C unless otherwise noted)

	Parameter	Symbol	Condition	Min.	Typ.	Max.	Unit
Fast axis	Optical deflection angle*1	θf_max		-22	-	+22	°
Slow axis	Drive current*2	$I s_dc$	DC current	-100	-	100	mAdc
	Optical deflection angle*1	θs_max		-14	-	+14	°
	Power consumption*3	P_{coil}		-	-	520	mW
	Operating temperature*4	T_{opr}	No dew condensation*5	-20	-	+60	°C
	Storage temperature	T_{stg}	No dew condensation*5	-40	-	+85	°C

*1: Angle at which the torsional stress of the torsion bars becomes large and the service life is shortened

*2: DC current that causes damage to the wiring. Because driving the device with a DC current can shorten the service life, driving the device with an AC current is recommended.

*3: Coil power consumption. It is given by the following equation.

$$P_{coil} = (R_s \times I_{s_rms}^2 + R_f \times I_{f_rms}^2) \times 2 \times 1000 \text{ [mW]}$$

I_{s_rms} , I_{f_rms} : Rms drive current

*4: Ambient temperature

*5: When there is a temperature difference between a product and the surrounding area in high humidity environment, dew condensation may occur on the product surface. Dew condensation on the product may cause deterioration in characteristics and reliability.

Note: Exceeding the absolute maximum ratings even momentarily may cause a drop in product quality. Always be sure to use the product within the absolute maximum ratings.

▣ Structure

	Parameter	Min.	Typ.	Max.	Unit
	Mirror size	$\phi 1.21$	$\phi 1.23$	$\phi 1.25$	mm
	Mirror material	Aluminum alloy			-
Operation mode	Fast axis	Non-linear mode (resonant mode)			-
	Slow axis	Linear mode			-

Recommended operating conditions

Parameter		Symbol	Condition	Min.	Typ.	Max.	Unit
Fast axis	Incident angle*6	ϕf		-15	0	+15	°
	Optical deflection angle*7	θf		-20	-	+20	°
	Drive frequency	ff		Resonant frequency*8			Hz
Slow axis	Incident angle*6	ϕs		-13	+20	+25	°
	Optical deflection angle*7	θs		-12	-	+12	°
	Drive frequency	fs		10	-	100	Hz
Operating temperature*9		Topr	No dew condensation*10	-20	+25	+60	°C

*6: Incident angle at which a $\phi 1$ mm collimated laser beam is incident on the mirror positioned at an optical deflection angle of 0° and at which the laser is within the effective area of the window material when scanning is performed at the recommended optical deflection angle

Definition of incident angle

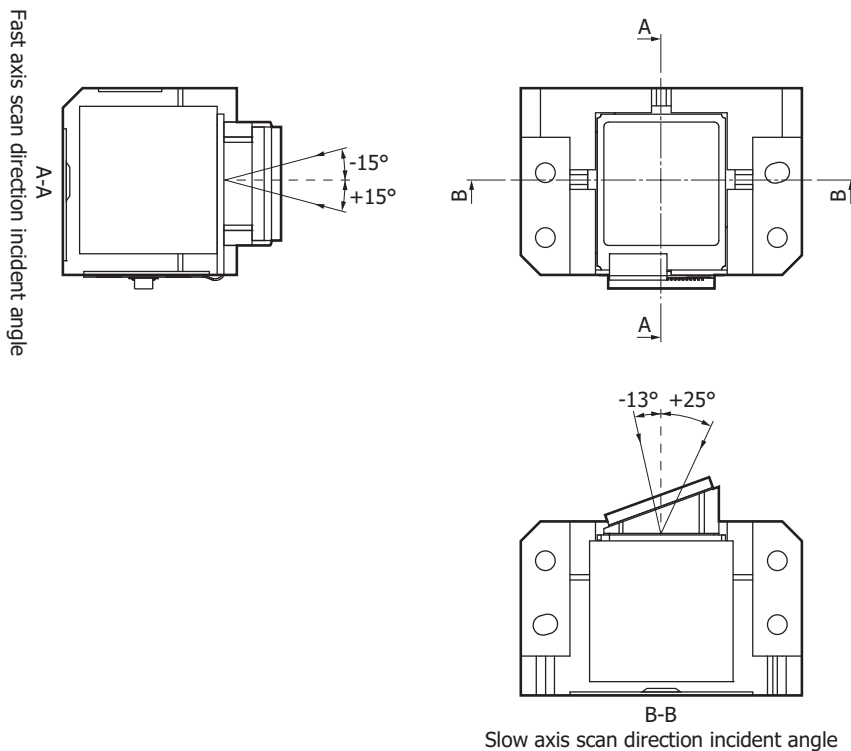

KOTH0081EA

*7: The optical deflection angle is twice the mechanical deflection angle. The light path is offset due to the refraction by the window material. This must be considered during use.

*8: The resonant frequency is different between individual devices and also varies depending on the operating conditions. We recommend using feedback control so that the drive frequency matches the resonant frequency.

*9: Ambient temperature. Recommended operating conditions: When used in this temperature range

*10: When there is a temperature difference between a product and the surrounding area in high humidity environment, dew condensation may occur on the product surface. Dew condensation on the product may cause deterioration in characteristics and reliability.

Electrical and optical characteristics (recommended operating conditions unless otherwise noted)

Parameter	Symbol	Condition	Min.	Typ.	Max.	Unit		
Reflectance*11	R	$\lambda=460$ to 640 nm	80	-	-	%		
Transmittance of window material*12	T	$\theta_{in}=0$ to 43° *13, $\lambda=460$ to 640 nm	95	-	-	%		
Fast axis	Resonant frequency	ff-r	$T_a=25$ °C, $\theta_f=\pm 20^{\circ}$, $I_s=0$ mA, square wave	28.6	29.3	30.0	kHz	
	Drive current	If	$T_a=25$ °C, $f_f=ff-r$, $\theta_f=\pm 20^{\circ}$, $I_s=0$ mA, square wave	12	22	34	mAmp.	
	Coil resistance	Rf	$T_a=25$ °C, $I_f=0.1$ mA, $I_s=0$ mA	7.5	10.5	13.5	Ω	
	Back electromotive force	Vf	$T_a=25$ °C, $\theta_f=\pm 20^{\circ}$, $I_s=0$ mA fast axis coil readout	23	28	33	mVamp.	
		Vs	$T_a=25$ °C, $\theta_f=\pm 20^{\circ}$, $I_s=0$ mA slow axis coil readout	16	20	24	mVamp.	
Slow axis	Resonant frequency	fs-r	$T_a=25$ °C, $I_s=0.3$ mAmp. (sin wave) $I_f=0$ mA	525	575	625	Hz	
	Quality factor	Qs	$T_a=25$ °C, $I_s=0.3$ mAmp. (sin wave) $I_f=0$ mA	320	400	480	-	
	Drive current	Is	$T_a=25$ °C $f_s=60$ Hz (sin wave) $I_f=0$ mA	$\theta_s=+12^{\circ}$	140	175	210	mAmp.
				$\theta_s=-12^{\circ}$	-210	-175	-140	mAmp.
Coil resistance	Rs	$T_a=25$ °C, $I_f=0$ mA, $I_s=0.1$ mA	6	8	10	Ω		
Temperature sensor	Resistance	Rth	$T_a=25$ °C, $I_{th}=0.1$ mA, $I_f=0$ mA, $I_s=0$ mA	230	300	370	Ω	
	Resistance temperature coefficient	α		0.36	0.38	0.4	%/°C	

*11: Using a white light source

*12: Average window material transmittance of polarized light p and s. Note that, after passing through the window material, the laser light is reflected by the mirror and passes through the window material again.

*13: Incident angle to the window material

Optical deflection angle

The optical deflection angle is twice the mechanical deflection angle.

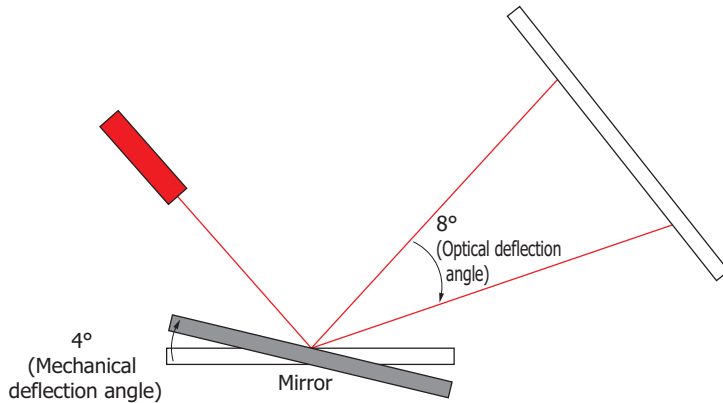

KOTH0070EA

Effect of tilting the window material

The S13989-01H has a window material tilted 20° relative to the slow axis scanning direction to achieve a highly reliable sealed package. The window material tilt is set so that the laser light reflected from the front or rear surface of the window does not enter the mirror scanning projection range.

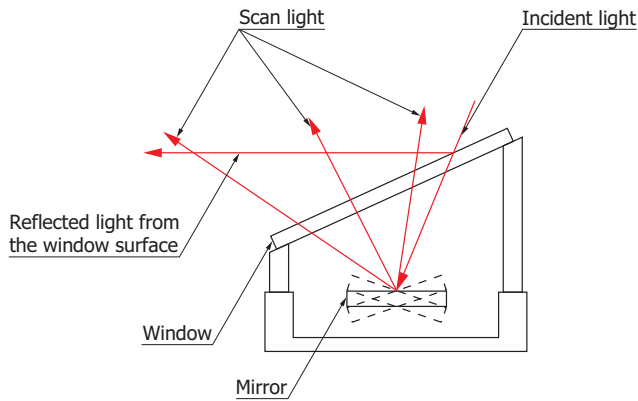

KOTH0082EA

Reflectance vs. wavelength

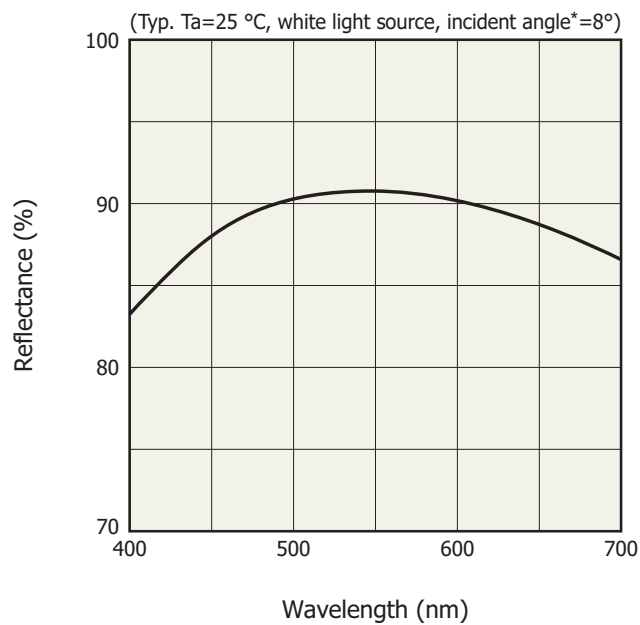

* Incident angle of light to the mirror

KOTH0060EA

Spectral transmittance of window material

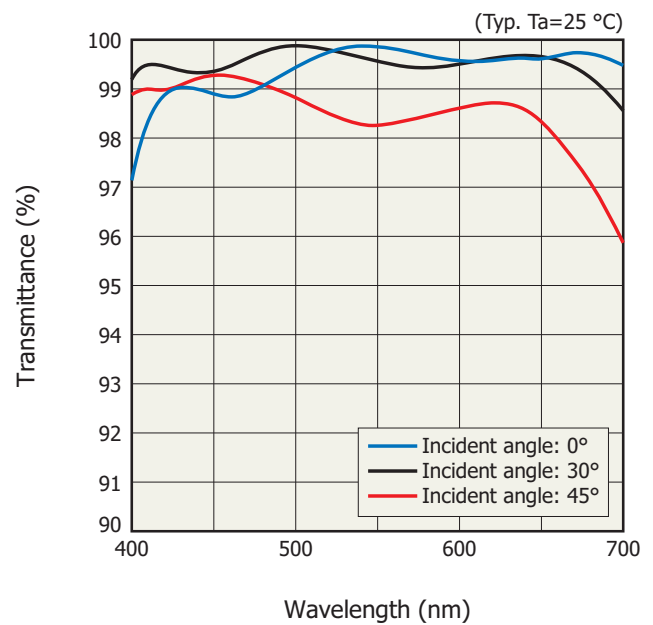

Note: Incident angle
=Angle of incidence of light on window material

KOTH0061EA

Optical deflection angle vs. drive current

Fast axis

Slow axis

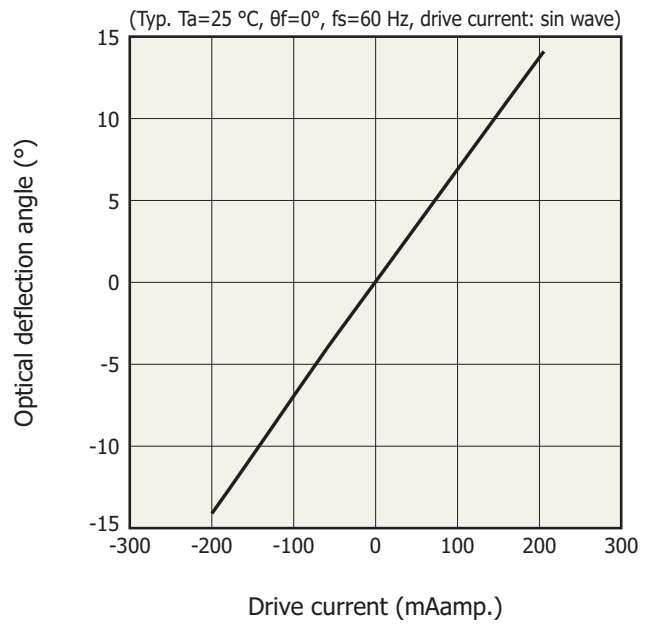
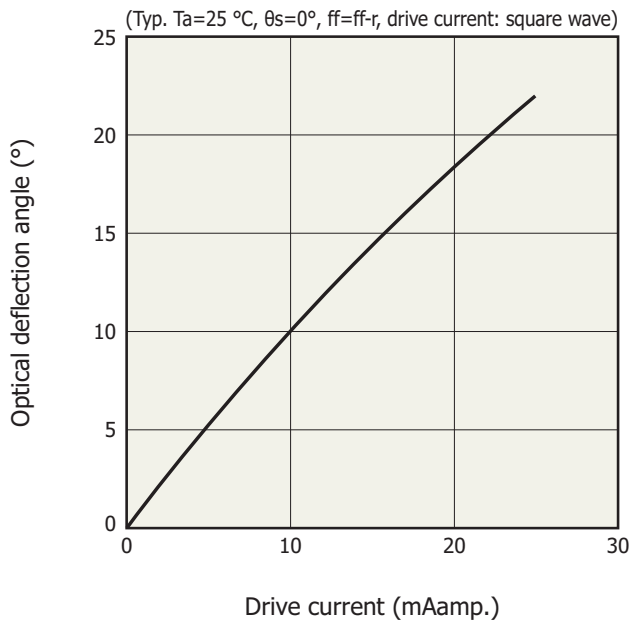

Maximum optical deflection angle vs. frequency (fast axis)

Optical deflection angle vs. frequency (slow axis)

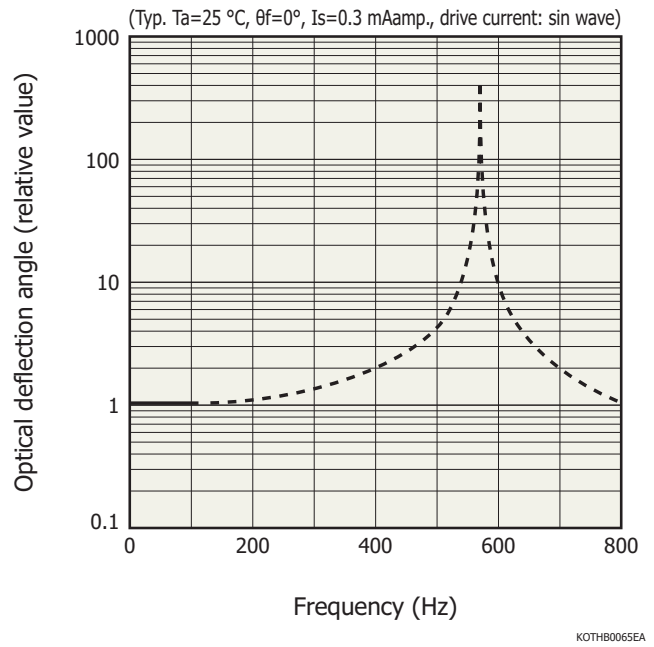
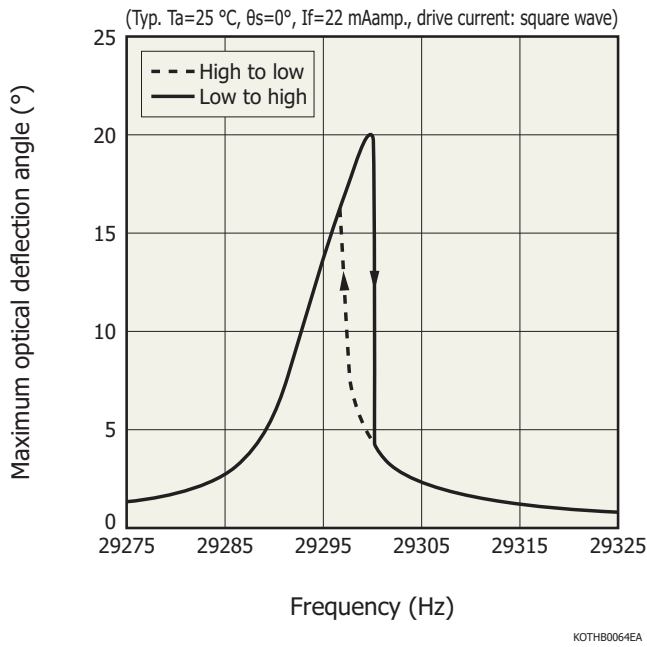

Dimensional outline (unit: mm)

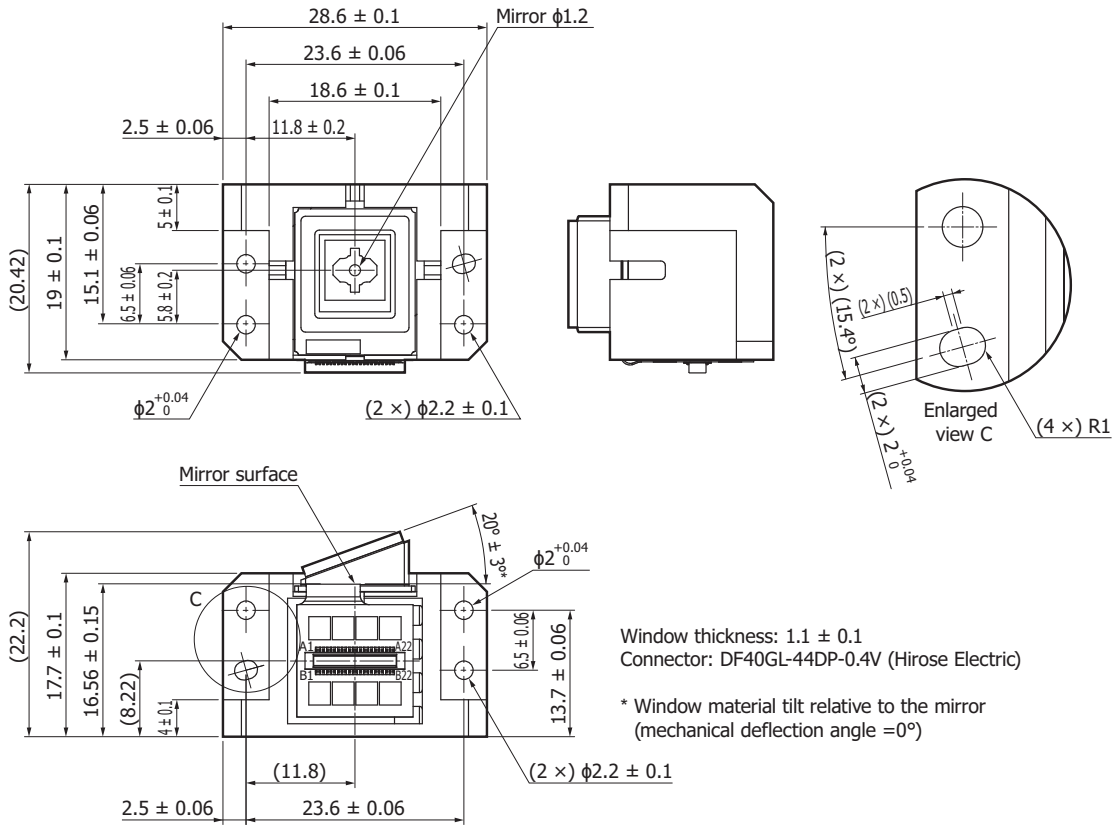

KOTHA0007EB

Pin connections

Pin no.	Connection	Pin no.	Connection
A1	Fast axis coil (+)	B1	Fast axis coil (+)
A2	Fast axis coil (+)	B2	Fast axis coil (+)
A3	NC	B3	NC
A4	NC	B4	NC
A5	NC	B5	NC
A6	Slow axis coil (+)	B6	Slow axis coil (+)
A7	Slow axis coil (+)	B7	Slow axis coil (+)
A8	NC	B8	NC
A9	NC	B9	NC
A10	NC	B10	NC
A11	Temperature sensor (+)	B11	Temperature sensor (+)
A12	Temperature sensor (-)	B12	Temperature sensor (-)
A13	NC	B13	NC
A14	NC	B14	NC
A15	NC	B15	NC
A16	Slow axis coil (-)	B16	Slow axis coil (-)
A17	Slow axis coil (-)	B17	Slow axis coil (-)
A18	NC	B18	NC
A19	NC	B19	NC
A20	GND	B20	GND
A21	Fast axis coil (-)	B21	Fast axis coil (-)
A22	Fast axis coil (-)	B22	Fast axis coil (-)

❑ Mechanical deflection direction of mirror due to drive current

The direction of the mirror's mechanical deflection varies depending on the direction of the drive current flowing through the coil as follows.

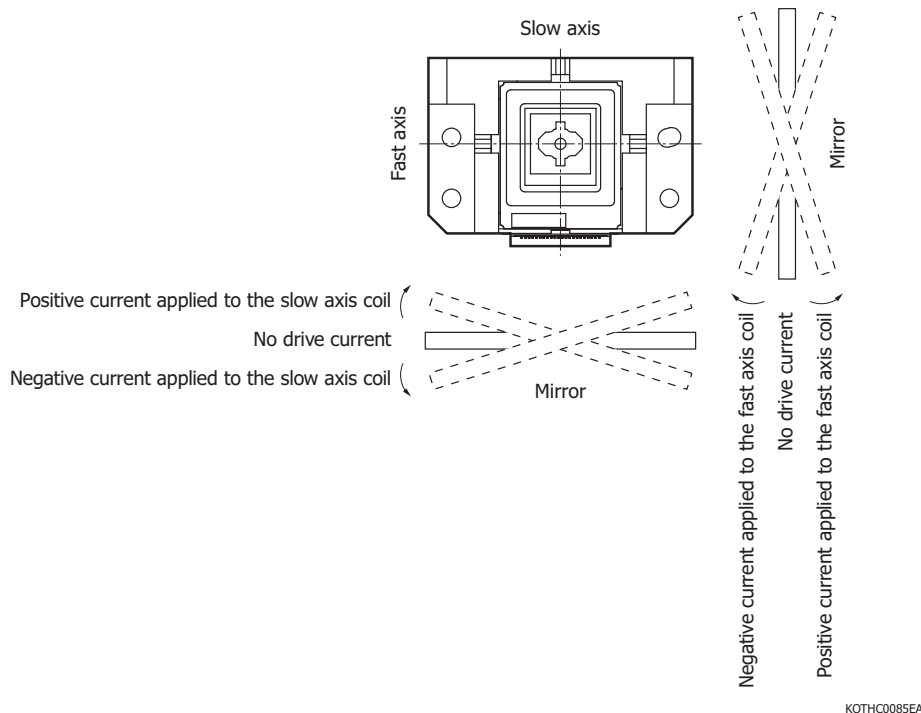

Note: As the drive frequency of the MEMS mirror increases, the phase lag of the optical deflection angle with respect to the drive current increases.

❑ Precautions

- See "Metal, ceramic, plastic package products / Precautions."
- A powerful magnet is inside the product. Bringing a magnetic body close to the product may damage the product. Therefore, we recommend using nonmagnetic screws and screwdrivers when fixing the product in place.
- Do not use in a strong magnetic field environment. The operating characteristics of the product may degrade due to the magnetic field.
- When carrying several products together, prevent each product from making contact with each other due to the attraction force of magnets, such as by fixing the products in place with space between them inside the container.
- Bringing the product near a person with electronic medical equipment (e.g., pacemaker) is dangerous. Never do so.
- Do not bring the product near magnetic tapes, prepaid cards, and the like. They may become unusable, or the magnetic recording may be corrupted.
- Bringing the product near electronic control equipment may affect instrument boards or control boards and may lead to failures or accidents. If you want to use the product with electronic control equipment, check that the equipment does not fail or cause accidents due to the magnet inside the product.
- The product may fail due to the damage that it receives when it is mounted. Be sure to inspect the product after mounting, and check that the product is working properly.
- Refer to Packaging Standard 953 in the ITA Dangerous Goods Regulations

Evaluation circuit for MEMS mirror C13884HC (sold separately)

The C13884HC is an evaluation circuit to simply evaluate the MEMS mirror S13989-01H. For the fast axis (non-linear mode), the mirror phase state is monitored and resonance driving is always performed. For the slow axis (linear mode), select from triangular wave, sine wave, or arbitrary waveform to drive the axis. A USB 2.0 interface is used to set the driving conditions of the MEMS mirror from the PC. A separate DC power supply is required to operate the product.

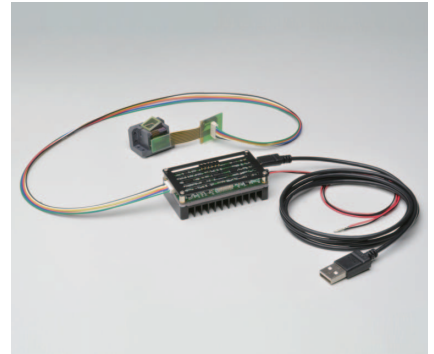

▣ Absolute maximum ratings

Parameter	Condition	Value	Unit
Operating temperature	No dew condensation*14	-20 to +60	°C
Storage temperature	No dew condensation*14	-40 to +85	°C
Supply voltage		6	V
Current consumption		1.5	A

*14: When there is a temperature difference between a product and the surrounding area in high humidity environment, dew condensation may occur on the product surface. Dew condensation on the product may cause deterioration in characteristics and reliability.

Note: Exceeding the absolute maximum ratings even momentarily may cause a drop in product quality. Always be sure to use the product within the absolute maximum ratings.

▣ Electrical specifications

Parameter		Min.	Typ.	Max.	Unit
Fast axis (non-linear mode)	Output waveform	Square wave			-
	Frequency	25000	-	40000	Hz
	Output current	-50	-	50	mA
Slow axis (linear mode)	Output waveform	Triangular wave, sine wave, or arbitrary waveform			-
	Frequency	5	-	100	Hz
	Output current	-220	-	220	mA
Supply voltage	4.0	5.0	5.5	V	
Current consumption	-	-	1.1	A	
Interface	USB 2.0				-

▣ Related information

www.hamamatsu.com/sp/ssd/doc_en.html

- Precautions
- Disclaimer

Information described in this material is current as of October 2020.

Product specifications are subject to change without prior notice due to improvements or other reasons. This document has been carefully prepared and the information contained is believed to be accurate. In rare cases, however, there may be inaccuracies such as text errors. Before using these products, always contact us for the delivery specification sheet to check the latest specifications.

The product warranty is valid for one year after delivery and is limited to product repair or replacement for defects discovered and reported to us within that one year period. However, even if within the warranty period we accept absolutely no liability for any loss caused by natural disasters or improper product use. Copying or reprinting the contents described in this material in whole or in part is prohibited without our prior permission.

HAMAMATSU

www.hamamatsu.com

HAMAMATSU PHOTONICS K.K., Solid State Division

1126-1 Ichino-cho, Higashi-ku, Hamamatsu City, 435-8558 Japan, Telephone: (81)53-434-3311, Fax: (81)53-434-5184

U.S.A.: Hamamatsu Corporation, 360 Foothill Road, Bridgewater, N.J. 08807, U.S.A., Telephone: (1)908-231-0960, Fax: (1)908-231-1218, E-mail: usa@hamamatsu.com

Germany: Hamamatsu Photonics Deutschland GmbH: Arzbergerstr. 10, D-82211 Herrsching am Ammersee, Germany, Telephone: (49)8152-375-0, Fax: (49)8152-265-8, E-mail: info@hamamatsu.de

France: Hamamatsu Photonics France S.A.R.L.: 19, Rue du Saule Trapu, Parc du Moulin de Massy, 91882 Massy Cedex, France, Telephone: (33)1 69 53 71 00, Fax: (33)1 69 53 71 10, E-mail: infos@hamamatsu.fr

United Kingdom: Hamamatsu Photonics UK Limited: 2 Howard Court, 10 Tewin Road, Welwyn Garden City, Hertfordshire AL7 1BW, UK, Telephone: (44)1707-294888, Fax: (44)1707-325777, E-mail: info@hamamatsu.co.uk

North Europe: Hamamatsu Photonics Norden AB: Torshamnsgatan 35 16440 Kista, Sweden, Telephone: (46)8-509 031 00, Fax: (46)8-509 031 01, E-mail: info@hamamatsu.se

Italy: Hamamatsu Photonics Italia S.r.l.: Strada della Moia, 1 int. 6, 20020 Arese (Milano), Italy, Telephone: (39)02-93 58 17 33, Fax: (39)02-93 58 17 41, E-mail: info@hamamatsu.it

China: Hamamatsu Photonics (China) Co., Ltd.: 1201 Tower B, Jiaming Center, 27 Dongsanhuan Beilu, Chaoyang District, 100020 Beijing, P.R.China, Telephone: (86)10-6586-6006, Fax: (86)10-6586-2866, E-mail: hpc@hamamatsu.com.cn

Taiwan: Hamamatsu Photonics Taiwan Co., Ltd.: 8F-3, No. 158, Section2, Gongdao 5th Road, East District, Hsinchu, 300, Taiwan R.O.C. Telephone: (886)3-659-0080, Fax: (886)3-659-0081, E-mail: info@hamamatsu.com.tw